



RAZER KISHI FOR ANDROID

MASTER GUIDE

Bring your A-game anytime, anywhere. Introducing a universal gaming controller that fits most Android devices, designed to bring console-level control to your mobile gaming. With this controller by your side, wherever you go, victory will follow.

CONTENTS

1. WHAT'S INSIDE / WHAT'S NEEDED.....	3
2. LET'S GET YOU COVERED.....	5
3. GETTING STARTED.....	6
4. USING THE RAZER KISHI APP.....	12
5. SAFETY AND MAINTENANCE.....	18
6. LEGALESE.....	19

1. WHAT'S INSIDE / WHAT'S NEEDED

WHAT'S INSIDE

- Razer Kishi for Android

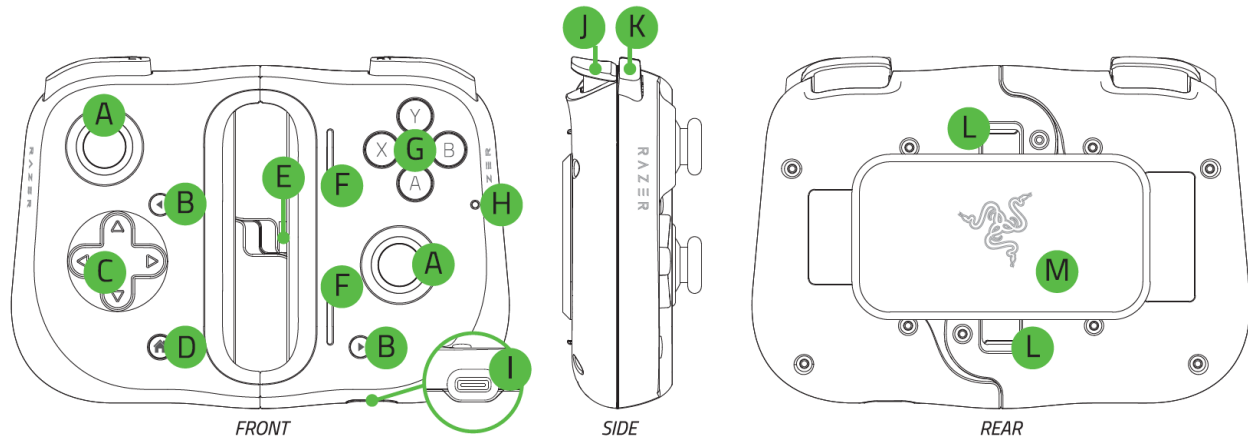

- A.** Clickable analog thumbsticks
- B.** Function buttons
- C.** 8-way D-pad
- D.** Special function button
- E.** Type C connector
- F.** Speaker ports
- G.** Face buttons

- H.** Status indicator
- I.** Type C port*
- J.** Triggers (L2/R2)
- K.** Bumpers (L1/R1)
- L.** Release latches
- M.** Retaining plate

**Only supports pass-through charging. Type C headphones and other accessories are not supported.*

- Important Product Information Guide

WHAT'S NEEDED

- Android™ 8.0 Oreo or higher*
- Internet connection for app installation

**Compatible with Razer Phone and Razer Phone 2 (requires rubber grips replacement), Samsung Galaxy S8 / S8+ / S9 / S9+ / S10e / S10 / S10+ / S20 / S20+ / Note 8 / Note 9 / Note 10 / Note 10+, Google Pixel 2 / 2 XL / 3 / 3 XL / 4 / 4 XL, and other Android devices.*

2. LET'S GET YOU COVERED

You've got a great device in your hands, complete with a 1-year limited warranty coverage. Now maximize its potential and score exclusive Razer benefits by registering at razerid.razer.com

*Your product's serial
number can be
found here.*

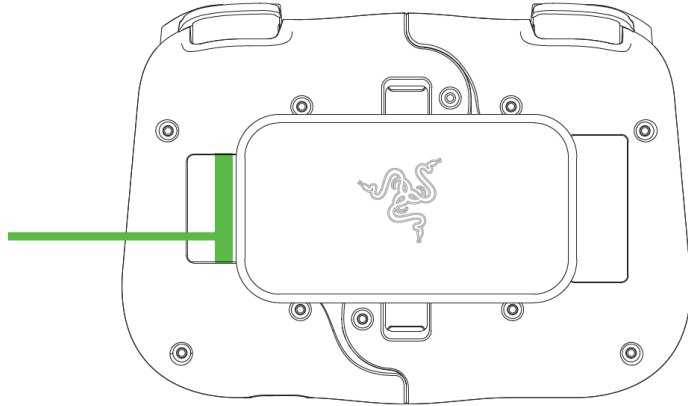

Got a question? Ask the Razer Support Team at support.razer.com

3. GETTING STARTED

EXPANDING YOUR CONTROLLER

Pull both of the release latches to unlock and remove the controller's retaining plate.

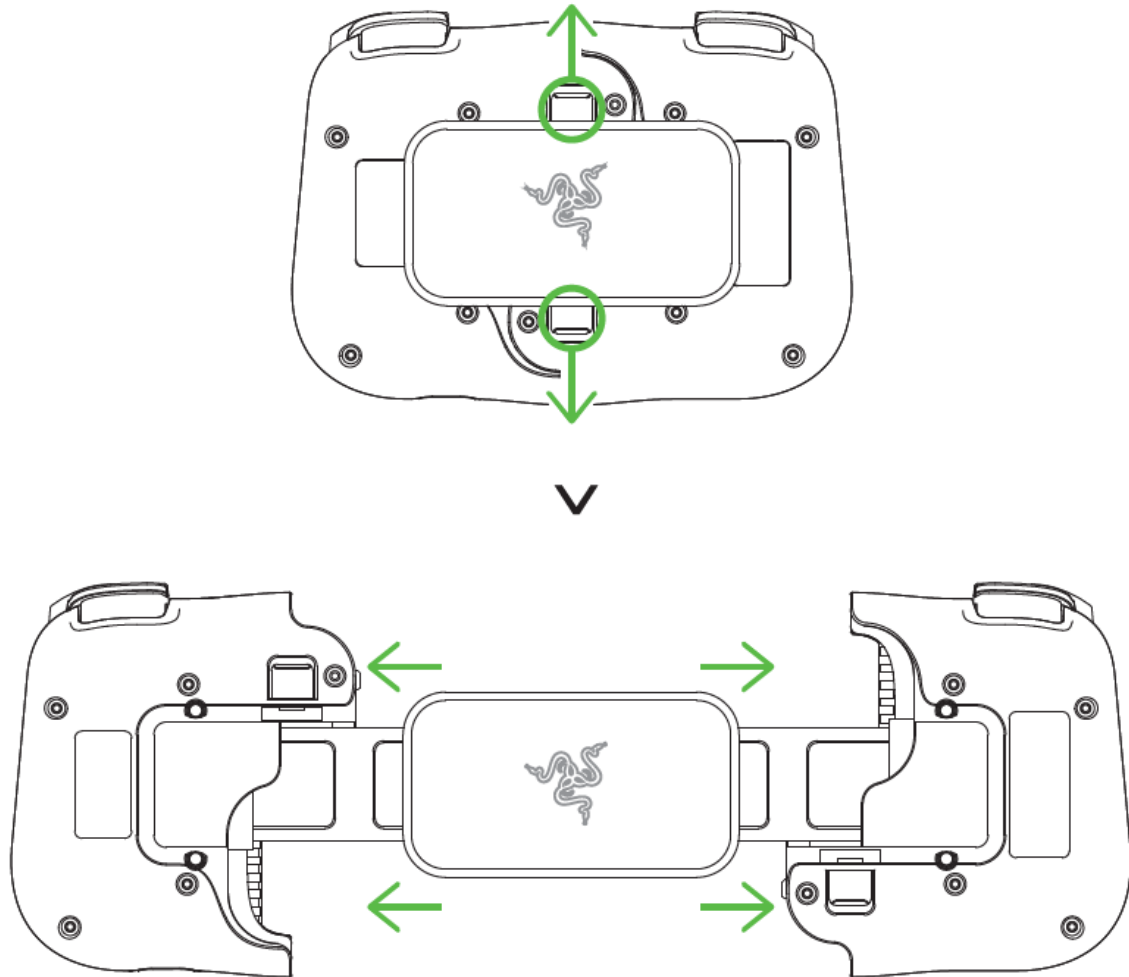

INSTALLING YOUR PHONE

Connect your phone's Type C port to the controller's Type C connector and gently pull the left side of the controller to cover the remaining side of your phone. The status indicator will briefly light up in blue to indicate that the controller is ready to use.

i *Maximum supported dimensions:
145.3 – 163.7 mm (Height) x 68.2 – 78.1 mm (Length) x
7.0 – 8.8 mm (Depth)*



CHANGING THE RUBBER GRIPS

i This is required if you want to use your controller with a Razer Phone or Razer Phone 2. Visit support.razer.com for details on how to claim the rubber grips for your phone.

Depending on which phone you're using on your controller, you may need to change the attached rubber grips to make sure your phone fits snugly into the controller.

Removal

Gently pull on an attached rubber grip until you can fully remove it from the controller. Repeat for the other rubber grip.

Installation

Firmly insert the upper portion of a rubber grip and then its remaining portion until fully inserted into the controller. Repeat for the other rubber grip.

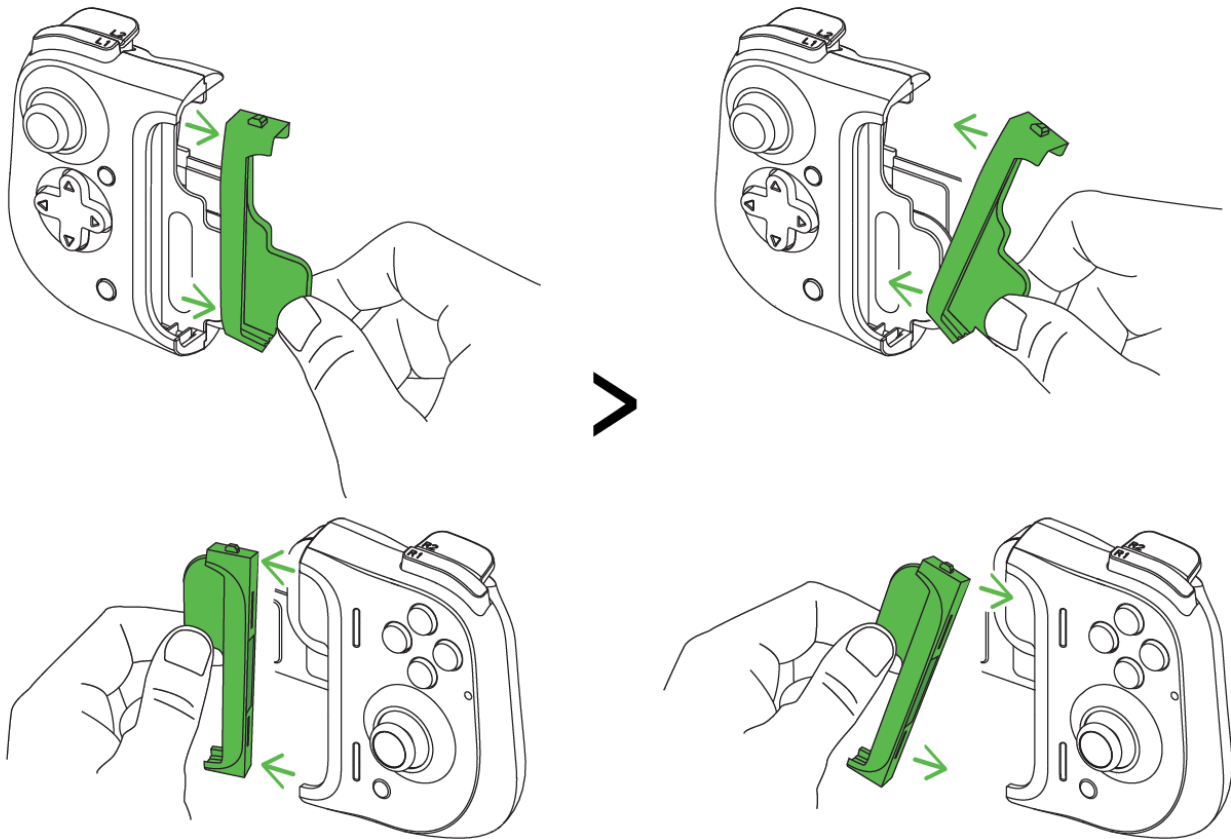

DETACHING YOUR PHONE

Firmly hold the right side of the controller and gently pull its left side to detach your phone.

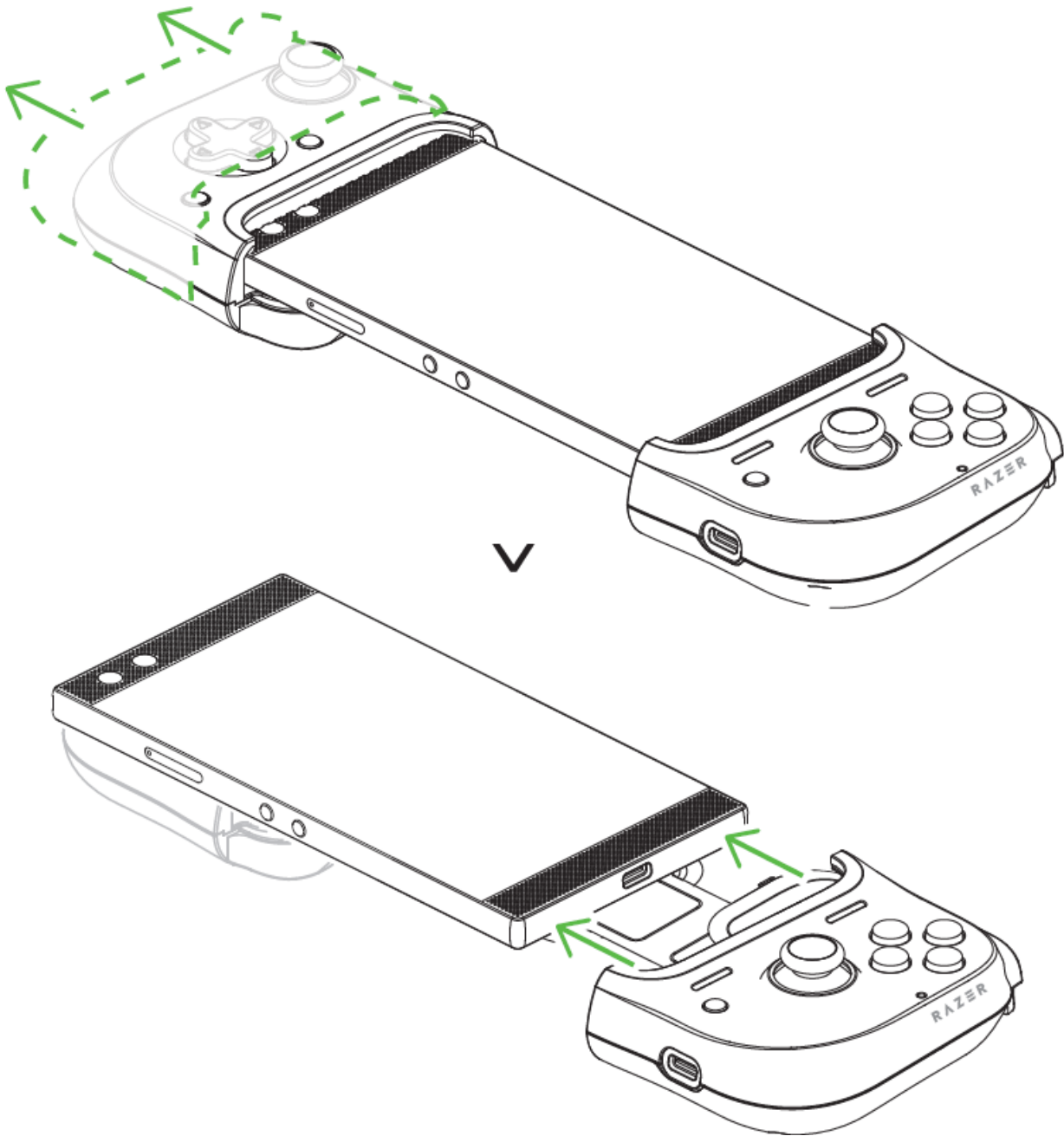

COLLAPSING YOUR CONTROLLER

When not in use, you can collapse the controller by bringing its two sides together; making sure that the both tabs are in the middle.

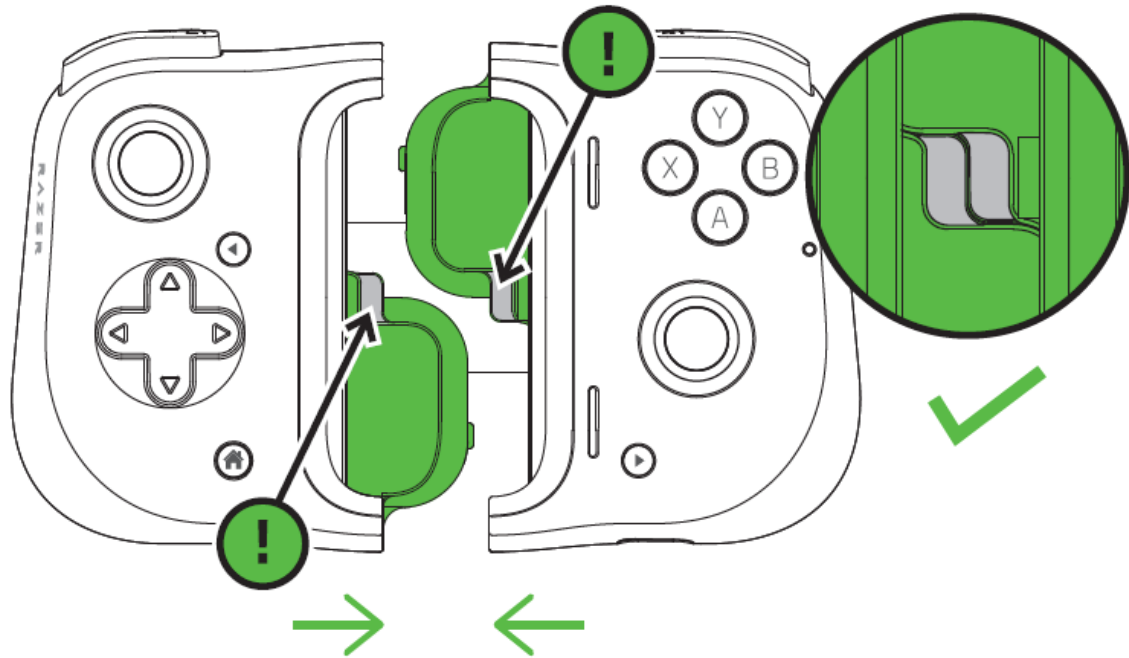

You may then gently press the retaining plate at the back until it snaps both sides in place.

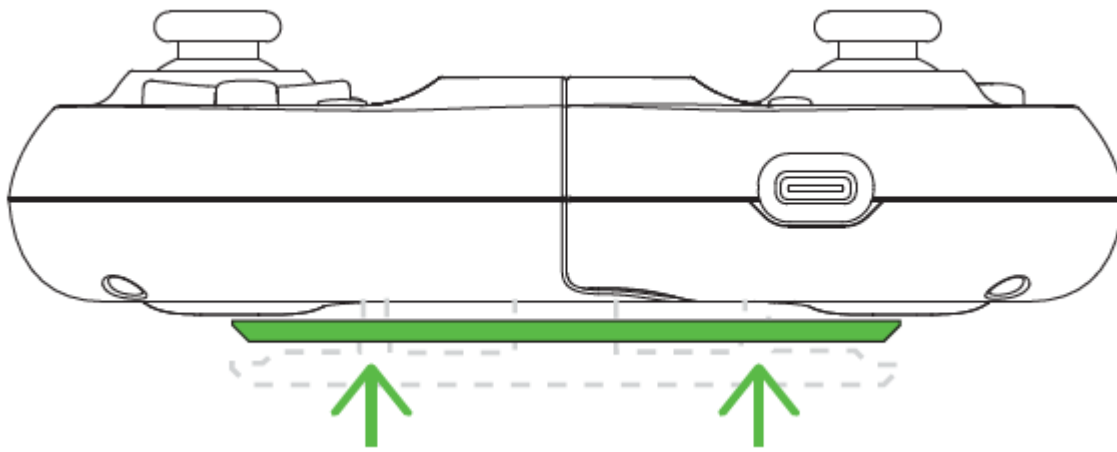

INSTALL THE RAZER KISHI APP

Download the Razer Kishi app and explore your way through all the compatible games available for your controller.



Razer Kishi

4. USING THE RAZER KISHI APP

i *Disclaimer: Internet connection is required for installation, updates and cloud-based features. Registering for a Razer ID account is recommended, but optional. All listed features are subject to change based on the current app version, and connected device(s).*

THE RAZER KISHI APP

Download the Razer Kishi app on your device to discover and directly launch tons of compatible games and even access firmware updates for your controller.

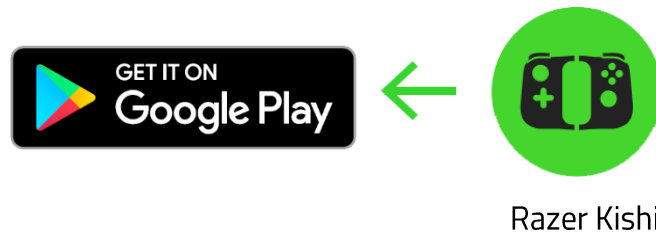

Launcher

The Launcher tab is the default page of the Razer Kishi app. From here, you'll be able to directly launch any compatible game installed on your phone, untested games which you've manually added into the app, as well as any game you've recently played.

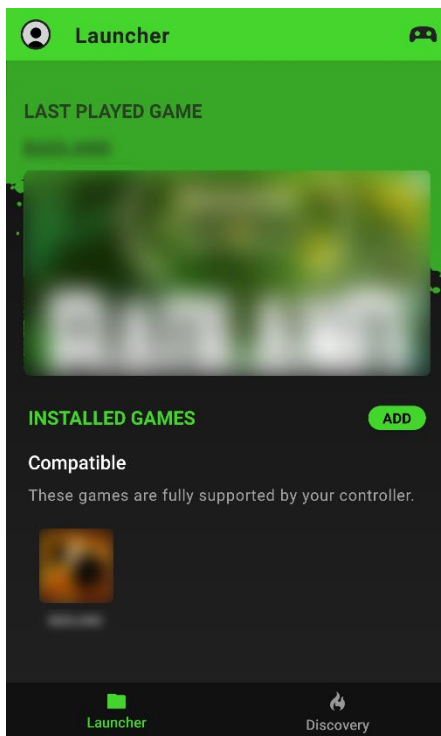

Controller Status

The controller icon () shows whether the controller is connected.

Compatible

Shows all compatible games currently installed on your phone. Tapping on any compatible game while your phone is connected to the controller, allows you to launch the game with the controller's preset controls.

i *By default, all compatible games installed on your phone are added into this tab.*

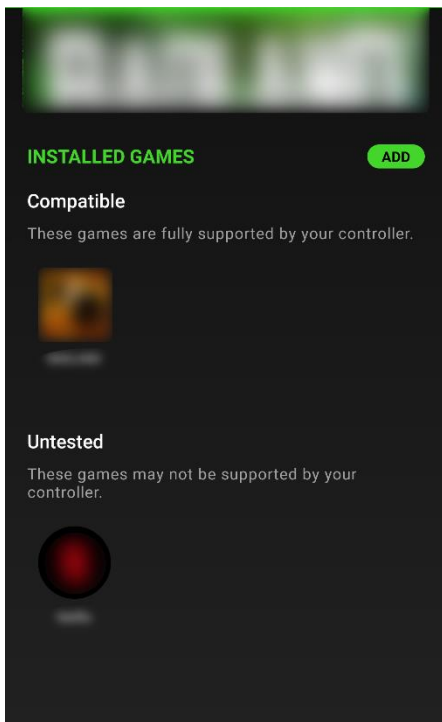

Untested

Displays all games you've manually added into the app.



Games listed under this category may or may not be supported by your controller.

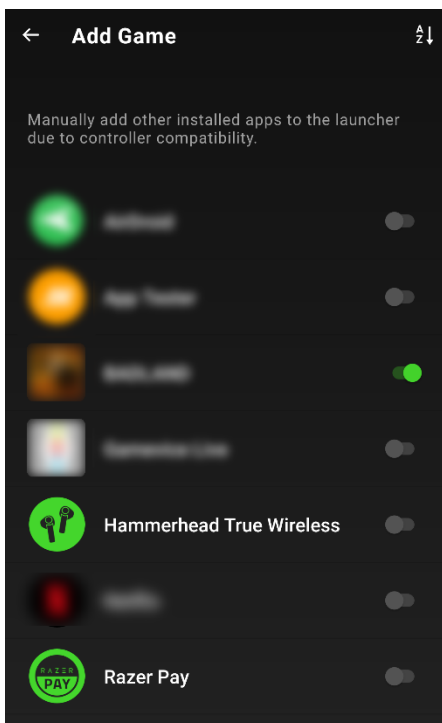

Adding games

To manually add games, tap the ADD button and enable or disable any of the listed apps that you want to use with your Razer controller.

Discovery

Visit the Discovery tab to see the hottest games supported on your controller. You may tap the miscellaneous icon (☰) to immediately jump to any of your preferred genres.

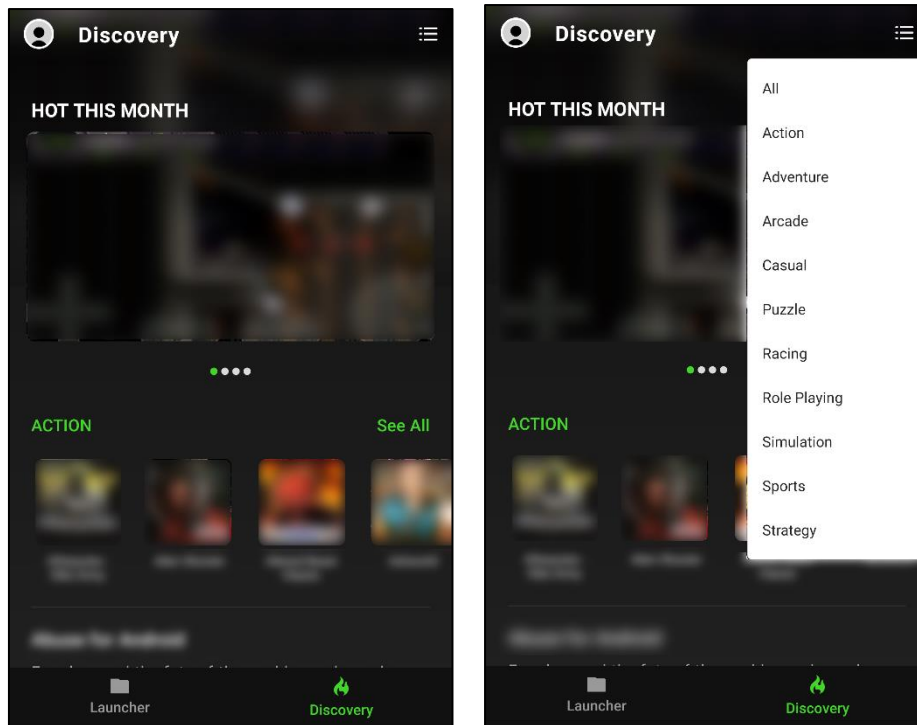

Avatar

Accessible anywhere on the app, your avatar allows you to check for firmware updates, edit your Razer ID account, provide feedback, view frequently asked questions and app details, and even sign out your account.

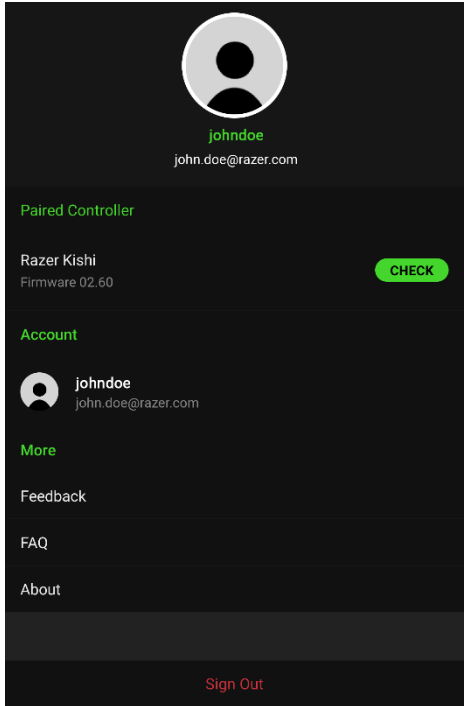

Paired Controller

Shows the device name and firmware version of the connected controller. You may also use this section to check for any available controller updates. [Learn more about firmware updates](#)

Account

Tap to change your avatar's display photo, change your Razer ID and manage other account settings.

Feedback

Report problems using your app's log files or send feature requests to the Razer team.

About

Displays brief app information, copyright statement and provides relevant links such as its Terms of Service, Privacy Policy, and Open Source Software Notice.

Firmware Updates

In the event that you're about to initiate a firmware update, the app will advise that you must first activate the controller's firmware update mode.

To activate firmware update mode on your controller:

1. Detach the phone from your controller.

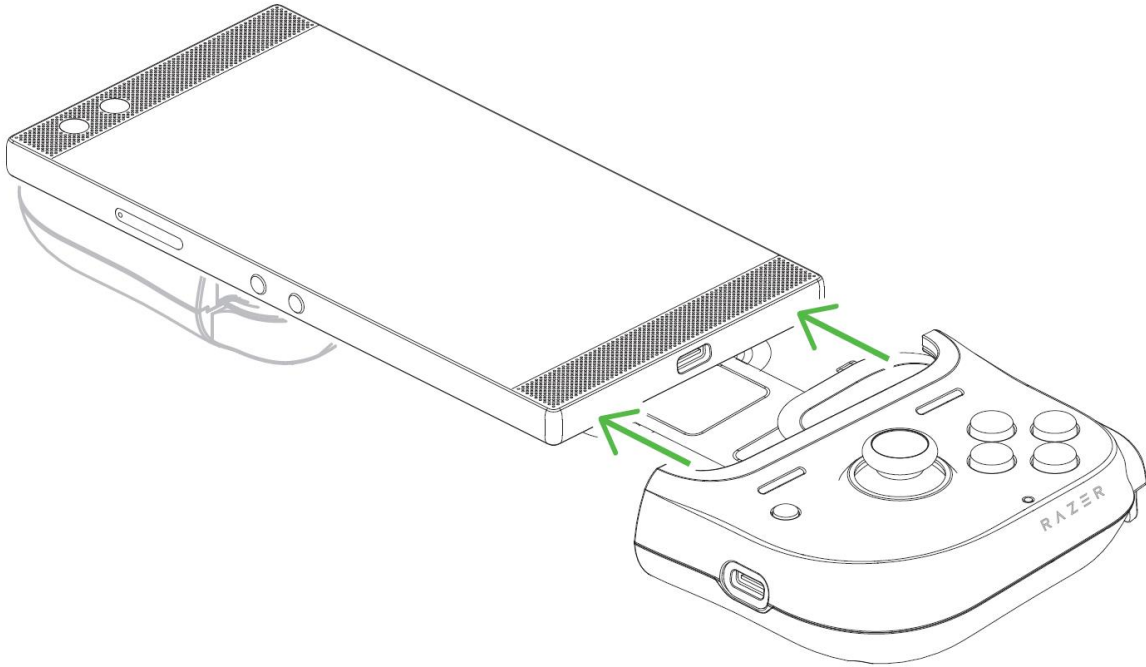

2. On your Razer controller, press and hold the **Y + B + Function (right)** buttons simultaneously.

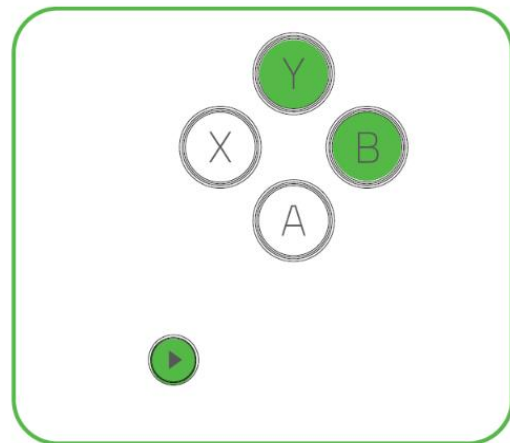
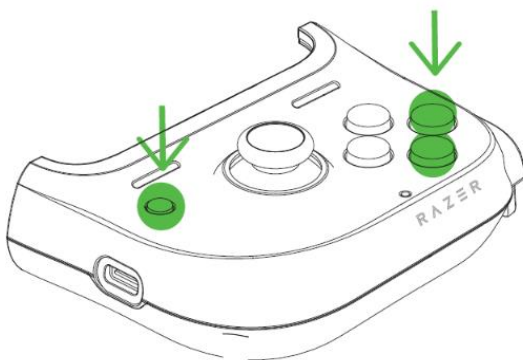

3. While holding the **Y + B + Function (right)** buttons, reattach your phone to the controller.

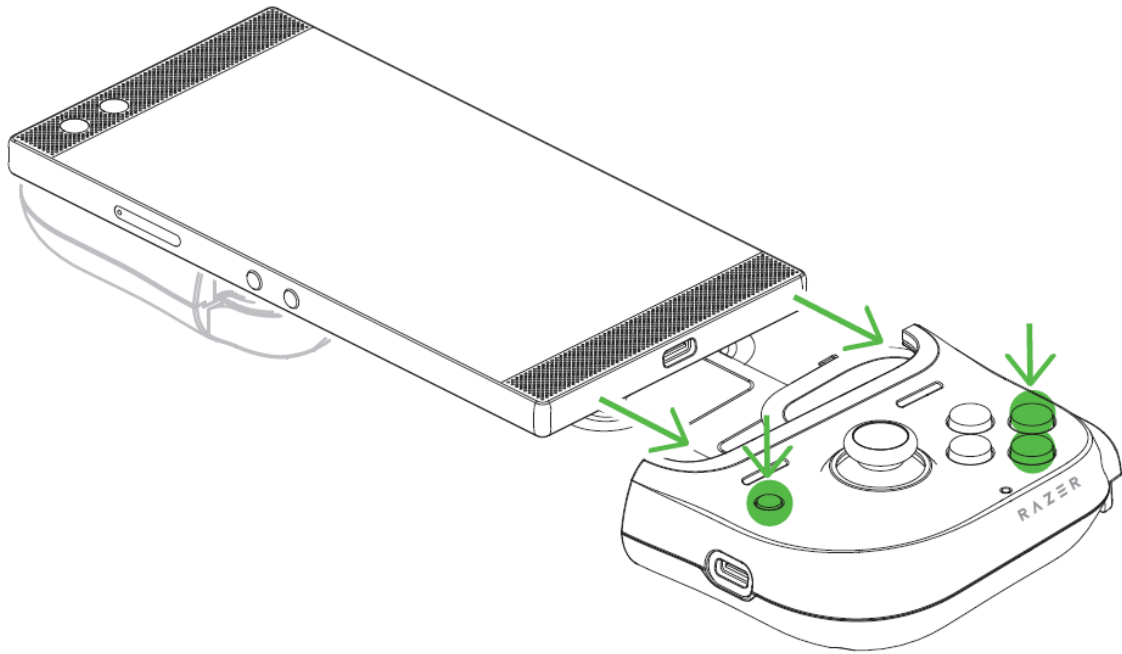

5. SAFETY AND MAINTENANCE

SAFETY GUIDELINES

In order to achieve maximum safety while using your Razer Kishi for Android, we suggest that you adopt the following guidelines:

Should you have trouble operating the device properly and troubleshooting does not work, make sure to unplug the device (if applicable) and contact the Razer hotline or go to support.razer.com for support.

Your phone should slide in and fit snugly into the device. Should you have trouble attaching your phone to the device, check if you're correctly sliding your phone's Type C port into the allotted Type C connector or if you're using the correct rubber grips for your phone. Don't forcefully jam your phone into the controller.

Don't take apart the device (doing so will void your warranty) and don't attempt to operate it under abnormal current loads.

Keep the device away from liquid, humidity or moisture. Operate the device only within the specific temperature range of 0°C (32°F) to 40°C (104°F). Should the temperature exceed this range, unplug and/or switch off the device in order to let the temperature stabilize to an optimal level.

MAINTENANCE AND USE

The Razer Kishi for Android requires minimum maintenance to keep it in optimum condition. Once a month, we recommend you detach your phone from the device, and gently clean the device using a soft cloth or cotton swab to prevent dirt buildup.

6. LEGALESE

COPYRIGHT AND INTELLECTUAL PROPERTY INFORMATION

©2020 Razer Inc. All rights reserved. Razer, the triple-headed snake logo, Razer logo, “For Gamers. By Gamers.”, “Powered by Razer Chroma” logo and Razer Phone 2 are trademarks or registered trademarks of Razer Inc. and/or affiliated companies in the United States or other countries. All other trademarks are the property of their respective owners.

©2018 Google LLC All rights reserved. Android, Google, Google Logo, Google Play, and the Google Play logo are registered trademarks of Google LLC.

Gamevice is a trademark of Gamevice, Inc., registered in the U.S. and other countries.

Razer Inc. (“Razer”) may have copyright, trademarks, trade secrets, patents, patent applications, or other intellectual property rights (whether registered or unregistered) concerning the product in this guide. Furnishing of this guide does not give you a license to any such copyright, trademark, patent or other intellectual property right. The Razer Kishi for Android (the “Product”) may differ from pictures whether on packaging or otherwise. Razer assumes no responsibility for such differences or for any errors that may appear. Information contained herein is subject to change without notice.

LIMITED PRODUCT WARRANTY

For the latest and current terms of the Limited Product Warranty, please visit razer.com/warranty.

LIMITATION OF LIABILITY

Razer shall in no event be liable for any lost profits, loss of information or data, special, incidental, indirect, punitive or consequential or incidental damages, arising in any way out of distribution of, sale of, resale of, use of, or inability to use the Product. In no event shall Razer’s liability exceed the retail purchase price of the Product.

GENERAL

These terms shall be governed by and construed under the laws of the jurisdiction in which the Product was purchased. If any term herein is held to be invalid or unenforceable, then such term (in so far as it is invalid or unenforceable) shall be given no effect and deemed to be excluded without invalidating any of the remaining terms. Razer reserves the right to amend any term at any time without notice.